

Codice
 Code

H1GS2305060

 Materiale: Acciaio con testate imbutite
 Material: Steel tank with deep-drawn heads

 Verniciatura: con polvere epossidica grigia (RAL 7021)
 Final coated: with grey epoxy powder (RAL 7021)

 Provvisti di: tappo di riempimento ventilato
 supporti saldati
 flangia per alloggiamento filtro ritorno
 spia livello olio
 Equipped with: breather filler cap
 welded supports
 return filter flange
 oil level eye

 Capacità: 35 lt * fino a livello olio
 Capacity: 35 lt* until oil level indicator

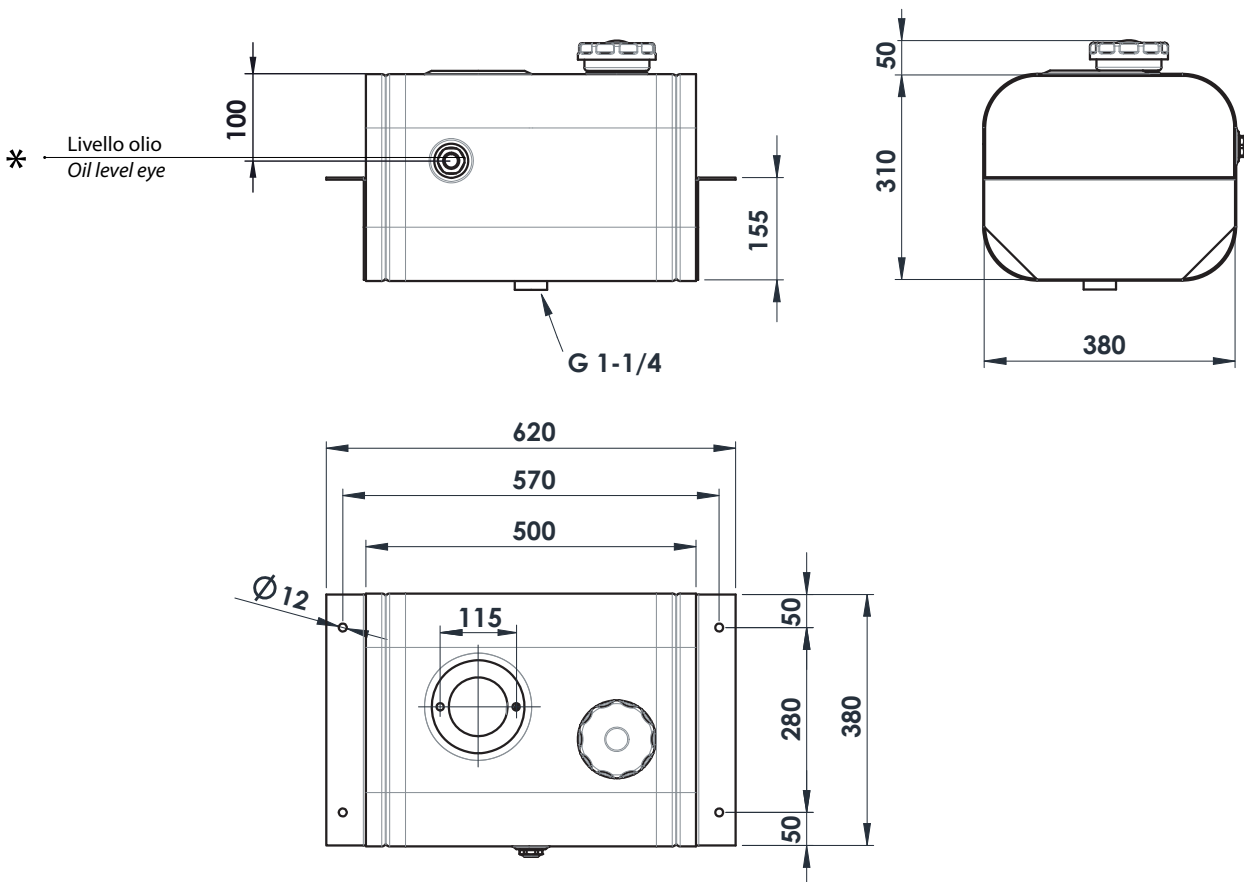
 Peso: 16 Kg
 Weight

11801300201 : TAPPO DI RIEMPIMENTO / FILLER CAP
 Già compreso nel serbatoio. Solo per ricambi
 Already included with the tank. Only for spare part

50900400123: LIVELLO OLIO / OIL LEVEL
 Già compreso nel serbatoio. Solo per ricambi
 Already included with the tank. Only for spare part

Collegamenti / Link:
[Accessori / Accessories](#)
[Istruzioni di montaggio / Mounting instructions](#)