

Codice
Code

H1GS1705060



Materiale: Acciaio con testate imbutite
Material: Steel tank with deep-drawn heads

Verniciatura: con polvere epossidica grigia (RAL 7021)
Final coated: with grey epoxy powder (RAL 7021)

Provvisti di: tappo di riempimento ventilato
supporti saldati
flangia per alloggiamento filtro ritorno
spia livello olio
Equipped with: breather filler cap
welded supports
return filter flange
oil level eye

Capacità: 29 lt * fino a livello olio
Capacity: 29 lt* until oil level indicator

Peso: 15 Kg
Weight

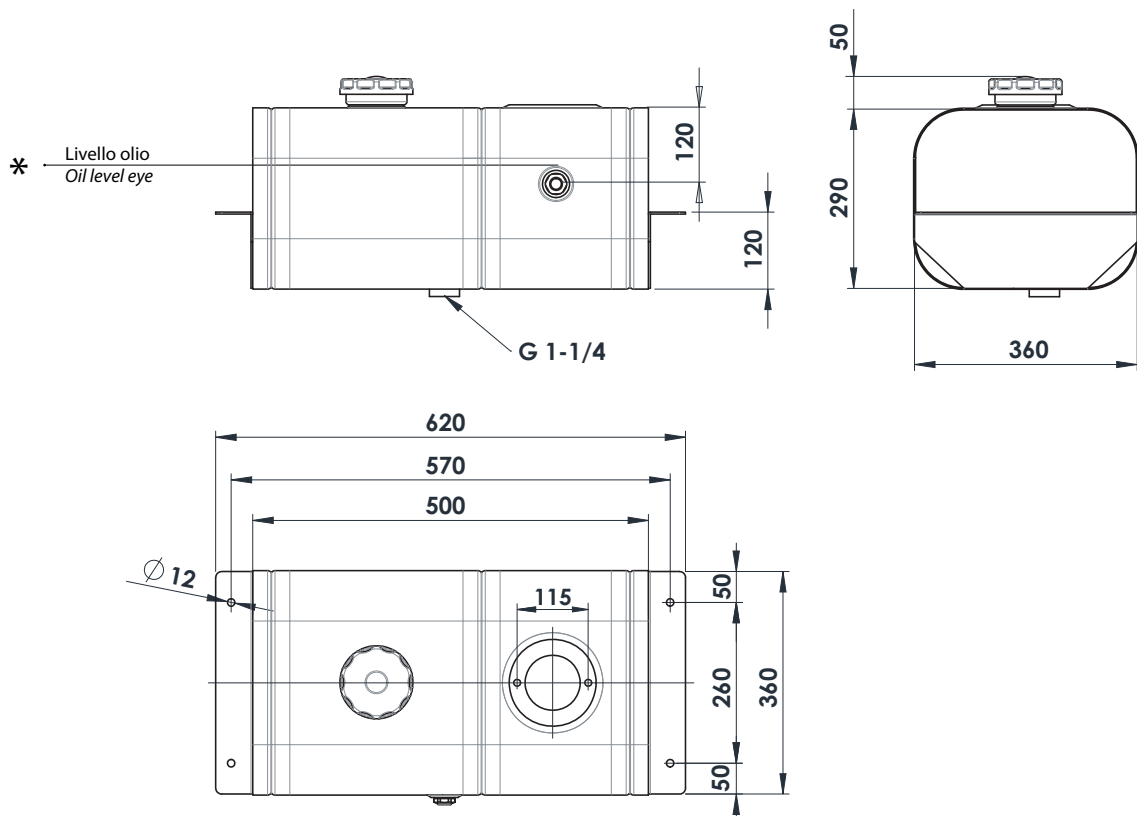

11801300201 : TAPPO DI RIEMPIMENTO / FILLER CAP
Già compreso nel serbatoio. Solo per ricambi
Already included with the tank. Only for spare part



50900400123: LIVELLO OLIO / OIL LEVEL
Già compreso nel serbatoio. Solo per ricambi
Already included with the tank. Only for spare part



Collegamenti / Link:

[Accessori / Accessories](#)

[Istruzioni di montaggio / Mounting instructions](#)