

Codice  
Code

**H1GS1105060**



Materiale: Acciaio con testate imbutite  
Material: Steel tank with deep-drawn heads

Verniciatura: con polvere epossidica grigia (RAL 7021)  
Final coated: with grey epoxy powder (RAL 7021)

Provvisti di: tappo di riempimento ventilato  
supporti saldati  
flangia per alloggiamento filtro ritorno  
spia livello olio  
Equipped with: breather filler cap  
welded supports  
return filter flange  
oil level eye

Capacità: 21 lt \* fino a livello olio  
Capacity: 21 lt\* until oil level indicator

Peso: 12,2 Kg  
Weight

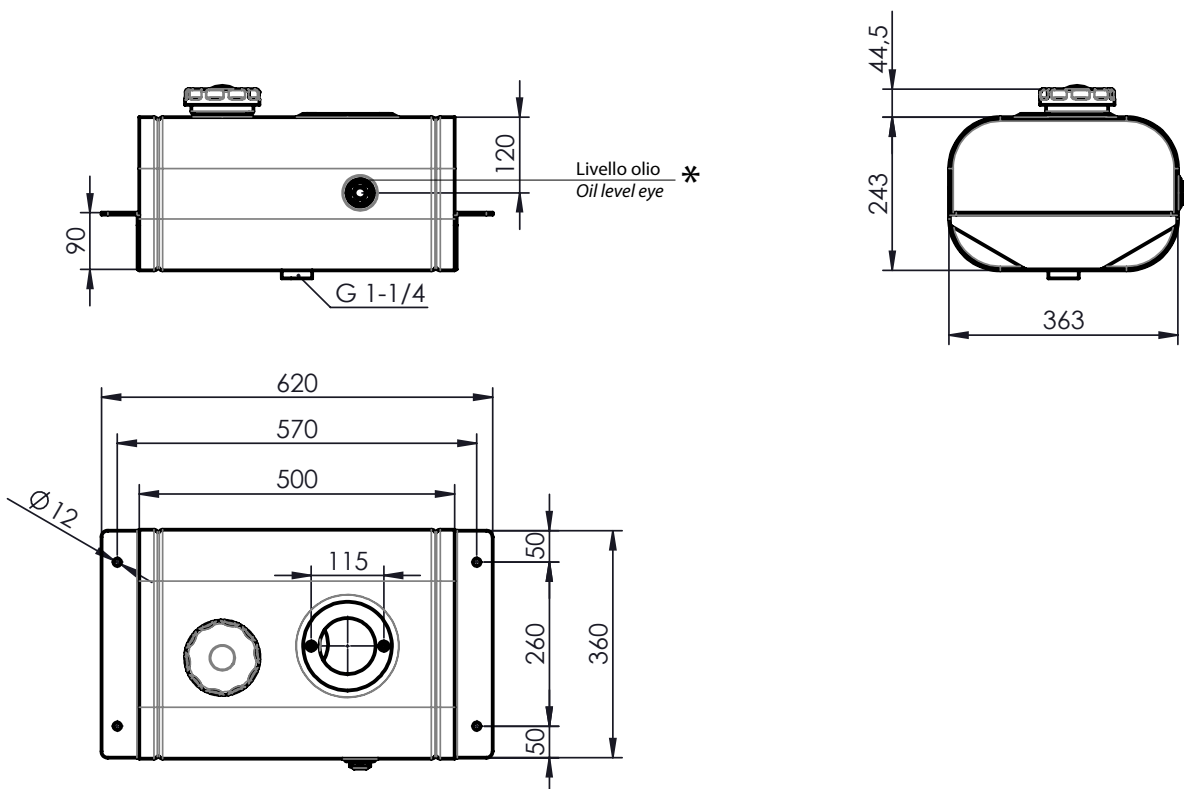

**11801300201 : TAPPO DI RIEMPIMENTO / FILLER CAP**  
Già compreso nel serbatoio. Solo per ricambi  
Already included with the tank. Only for spare part



**50900400123: LIVELLO OLIO / OIL LEVEL**  
Già compreso nel serbatoio. Solo per ricambi  
Already included with the tank. Only for spare part



Collegamenti / Link:

[Accessori / Accessories](#)

[Istruzioni di montaggio / Mounting instructions](#)