

Codice Code	Tensione Voltage	H	Ø	Portata ventola Fan power	M.R.	Corrente assorbita Current consumpt	Portata Oil flow	Potenza dissipata Dissipating power	Pressione di lavoro Working pressure
12201912080	12V	170mm	225mm	689 m ³ /h	3,43 dm ³	7,2 A	16-100 l/min	6-12 kW	14 bar
12201924080	24V	170mm	225mm	683 m ³ /h	3,43 dm ³	3,6 A			

M.R. = Massa radiante / Radiator core

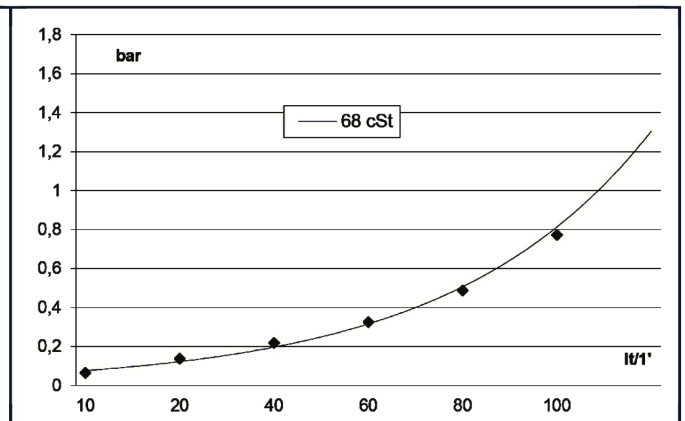
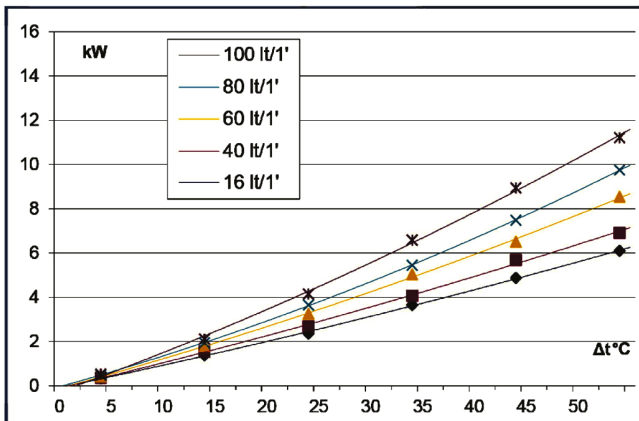
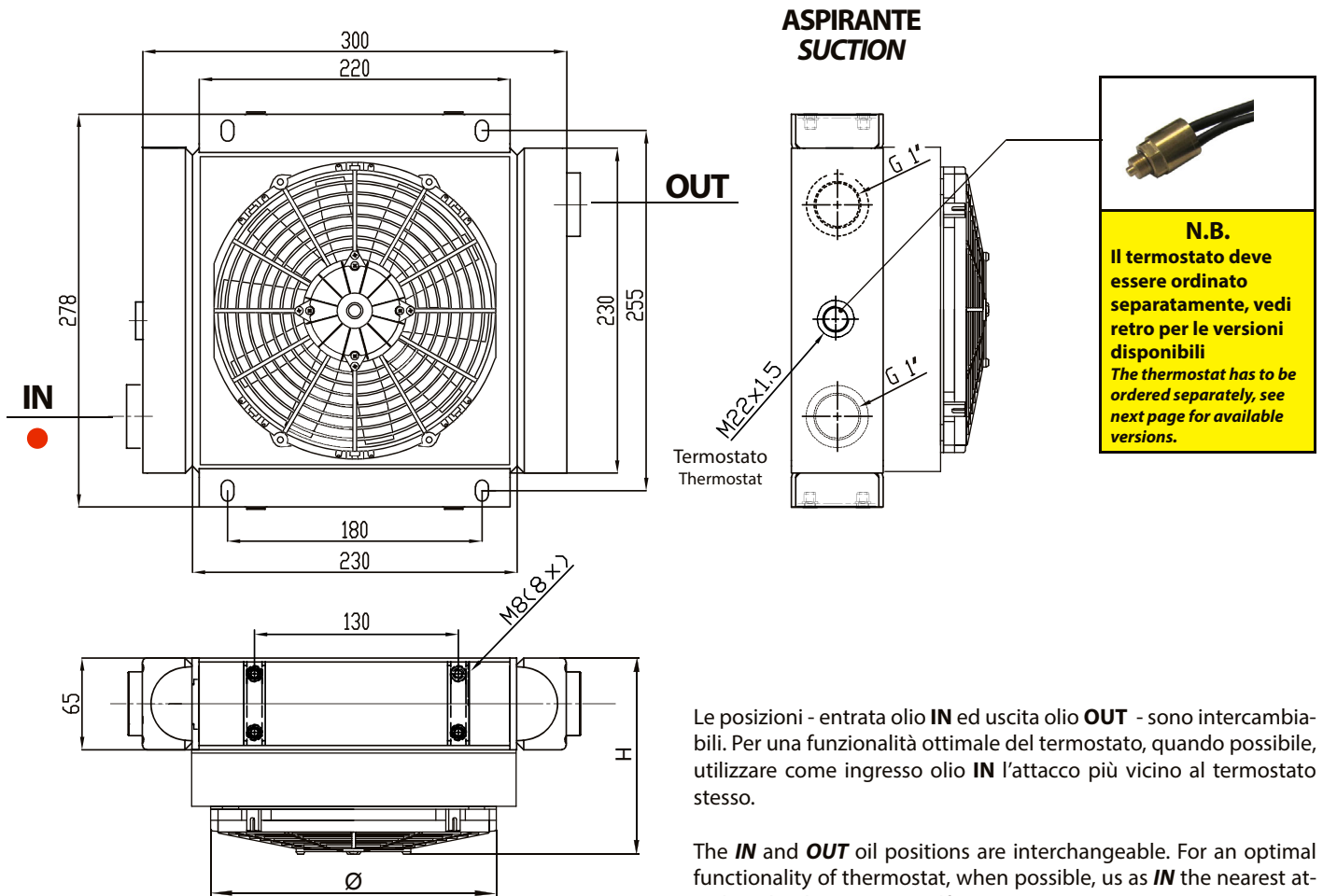

I termostati per gli scambiatori serie SDC-MP vengono forniti già completi di cablaggio per semplificare e velocizzare le operazioni di installazione. Due le versioni disponibili: ON-OFF e Soft Start progressivo, integrano entrambi l'uscita di potenza nell'involucro del termostato stesso, non è quindi necessario l'utilizzo di relè esterni.

The thermostats for heat exchanger series SDC-MP are supplied with wiring kit already included to make installation easier and quicker. There are two versions available: ON/OFF and progressive Soft Start. They both offer power output from the casing of the thermostat itself, therefore the use of an external relay is not required.

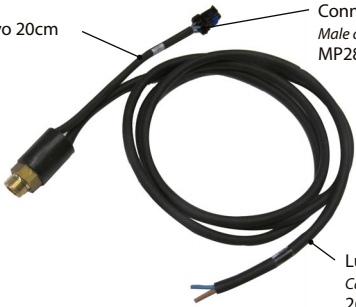

Lunghezza cavo 20cm
Cable length

Connettore maschio
Male connector
MP280

Lunghezza cavo
Cable length
260cm

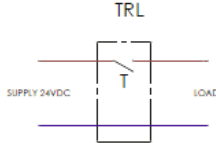

TRL

SUPPLY 24VDC

LOAD

Cod. 12291701128				Cod. 12291701244			
Termostato / Thermostat 46/60°C				Termostato / Thermostat 46/60°C			
Tensione Voltage	Corrente max. Max. current	Temperatura intervento Operation temperature		Tensione Voltage	Corrente max. Max. current	Temperatura intervento Operation temperature	
		ON	OFF			ON	OFF
12V	25A	60°C	46°C	24V	25A	60°C	46°C

Protezione / Protection IP67

Versione ON-OFF

ON-OFF version

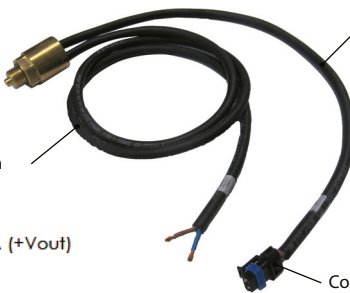
Lunghezza cavo 150cm
Cable length

Lunghezza cavo
Cable length
60cm

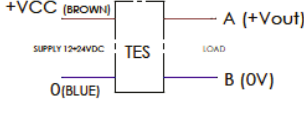

+VCC (BROWN)

SUPPLY 12-24VDC

TES

LOAD

0 (BLUE)

A (+Vout)

B (0V)

Connettore maschio
Male connector
MP280

Cod. 12291701002			
Termostato / Thermostat prop. 50/60°C			
Tensione Voltage	Corrente max. Max. current	Temperatura intervento Operation temperature	
		START	100%
12-24V	25A	50°C	60°C

Protezione / Protection IP67

VERSIONE SOFT START / SOFT START VERSION

La versione Soft Start è multitemperatura, si presta quindi ad essere utilizzato con scambiatori sia a 12 che a 24 V. L'avviamento della ventola avviene al raggiungimento della soglia minima di intervento di 50°C ed incrementa la velocità progressivamente fino alla soglia massima di 60°C.

The Soft Start version is multivoltage and it can work with both 12 and 24V coolers. The fan starts up once you reach the minimum operation threshold of 50°C and speeds up progressively until the maximum threshold of 60°C is reached.

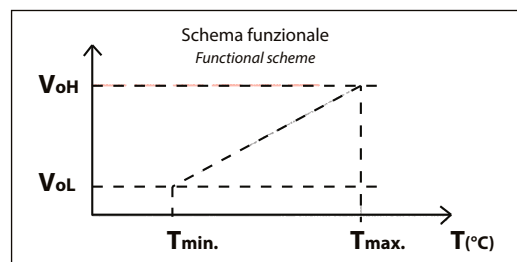

Lo scambiatore va posizionato sulla tubazione di ritorno e va protetto contro eventuali picchi di pressione che ne danneggerebbero la massa radiante. Si consiglia di interporre una valvola di By-pass tarata a 5 bar (da ordinare separatamente) per le versioni standard mentre nelle versioni By-pass è già incorporata nello scambiatore stesso.

The heat exchanger has to be placed on the return line and has to be protected by pressure peaks that can damage the radiator core. We suggest to use a by-pass valve set at 5 bar (to be order separately) for the standard versions. On the contrary the By-pass version offers already this feature as a standard.

