

ASSEMBLY INSTRUCTIONS

12101000252

Codice foglio: 99700100865

- 1) Identificare la posizione in cui verrà fissato il telecomando;
Find out the location where the cable control will be mounted.

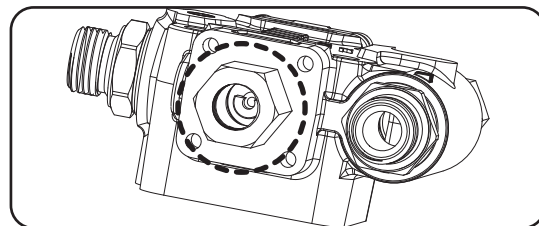

- 2) Verificare che il telecomando abbia l'estremità come rappresentata in figura;
Be sure that the cable control must have the terminal as shown in the picture.

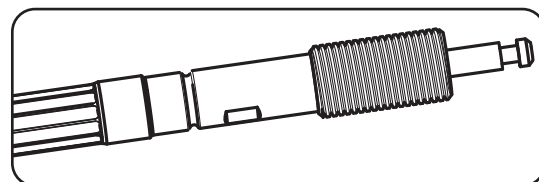

- 3) Far fuoriuscire completamente il cavo di acciaio;
Stick out the steel wire fully.

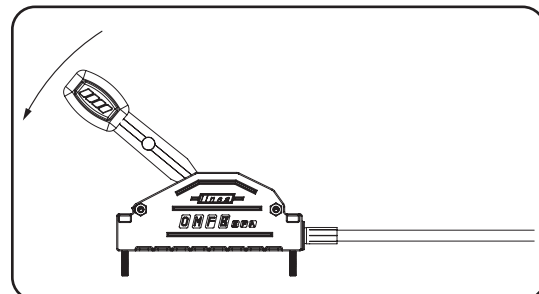

- 4) Inserire il terminale del cavo, agganciandolo come rappresentato nel disegno seguente:
Insert the terminal of the cable control and attach it as shown in the following picture.

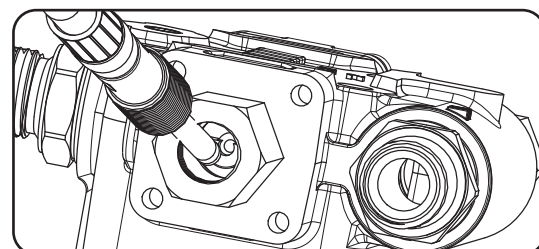
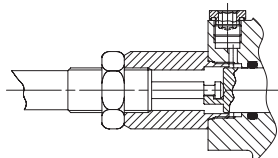

- 5) Avvitare la guaina del telecomando, serrandola fermamente, aiutandosi con due chiavi fisse.
Screw the cable tightly, helping yourself by using two spanners.

CH 24

CH 12

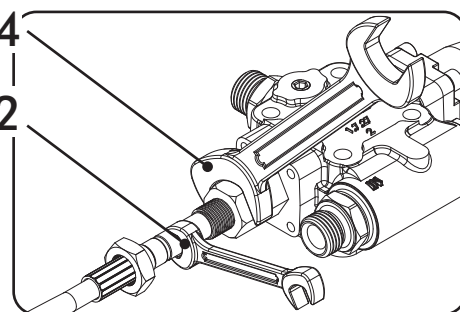

- 6) Bloccare il controdado sull'innesto utilizzando due chiavi fisse
Tight the counter-nut by using two spanners.

CH 24

CH 12

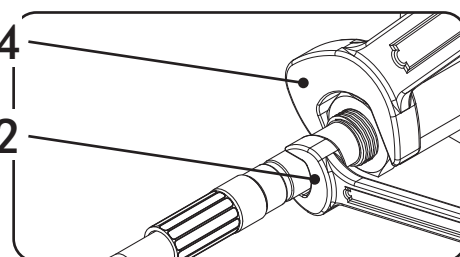

//

Data: Martedì 29 marzo 2005